

Beaded  
*Classic*

# Window Installation Guide



**PART L** Compliant ✓

 **SHEERLINE**<sup>®</sup>  
ALUMINIUM WINDOWS AND DOORS

  
whiteline

# Contents

## p3 Survey

Survey & Pre-Installation	3
---------------------------	---

## p4 Window Installation

Cill Preparation	4
Frame Fitting	5
Glazing Openers and Dummy Sashes	6
Glazing Fixed Panes	7
External Finishing & Final Checks	8

## p9 Optional

Operational Sash Removal	9
Dummy Sash Removal	10
Fixed Pane Removal	11
Operational Sash Fitting	12
Dummy Sash Fitting	13
Video Links	14



# Survey & Pre-Installation

Check the aperture to make sure that there is no loose plaster or brickwork, and that it is free of any debris or brick dust.

Frame size = brick to brick size – 5mm each side, so that the window can be installed level and square.

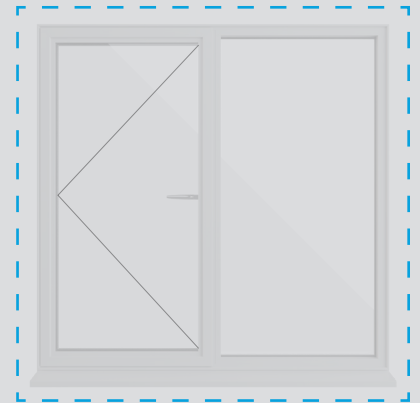

1.

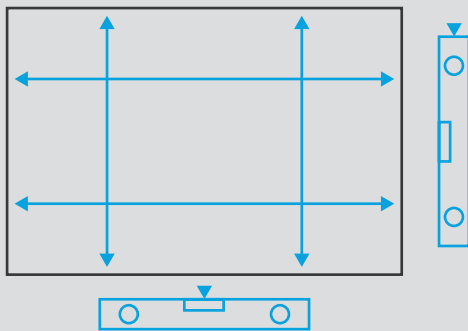

Ensure that all four sides of the aperture are plumb and square and identify any potential packing points.

2.

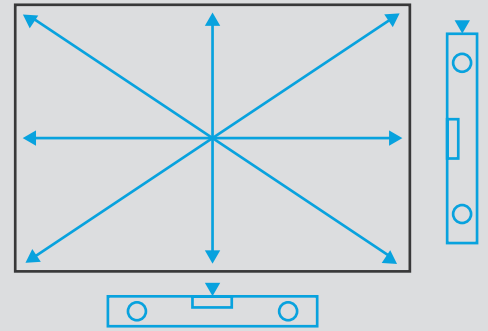

Check that the cill is level and provides a solid base to ensure it will not cause distortion of the window.

*Note: The window should be packed under the cill and frame jambs to provide sufficient support.*

**Check for alignment at points shown.**

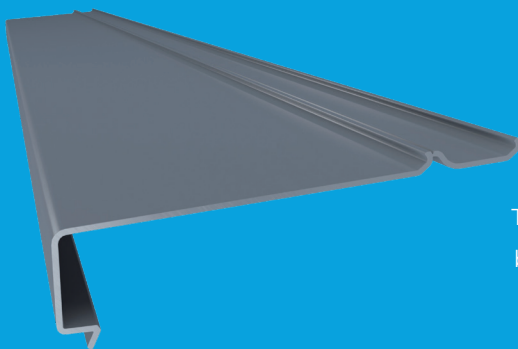

## Cill Protector

**SA516 Reusable Cill Protectors** are available from Sheerline. These help prevent damage on renovations and new-builds where building work will continue after the windows have been installed.



# Cill Preparation

The cill can either be cut square with the width of the window or cut with an additional 100mm on either side to form a traditional horn around the brickwork.



3.

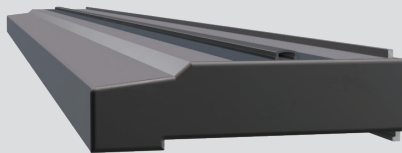

Secure end caps to the cill using a suitable adhesive.

4.

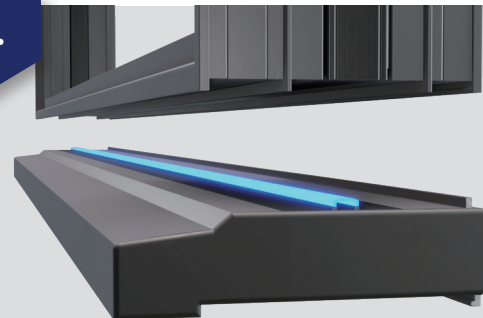

A co-extruded gasket seals between the frame and cill along its length without the need for additional sealant.

5.

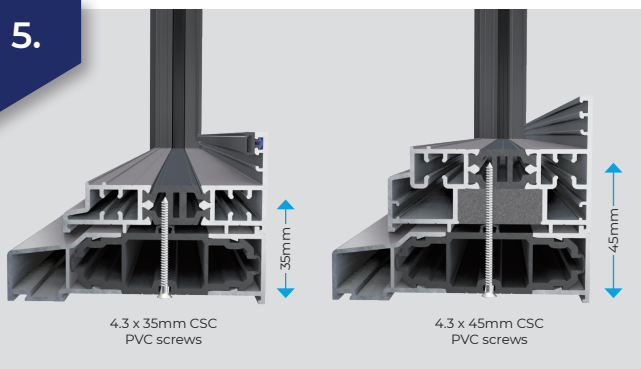

Fix through the cill into the window frame using countersunk PVCu screws as shown above, taking care that they do not break into the internal glazing rebate.

6.

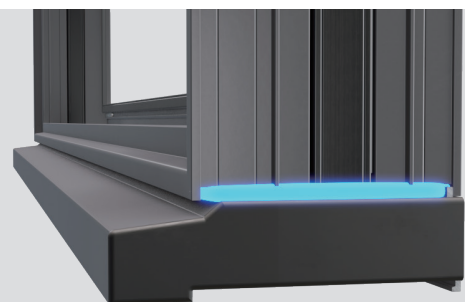

Seal with silicone along the edge where the cill meets the frame



whiteline

# Frame Fitting

NOTE: Cill packers & screws are not supplied

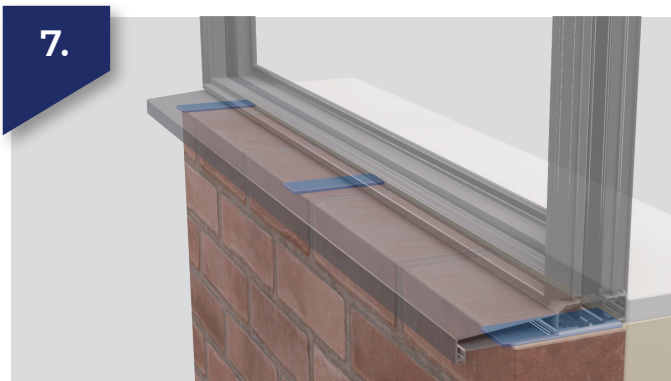
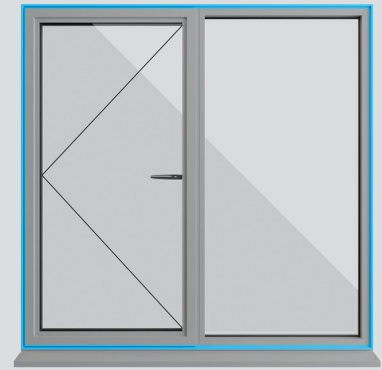

Pack under cill and window jambs and seal along the aperture cill in preparation for installation. It is good working practice to set outer frame 30mm in from the front face of the brickwork.

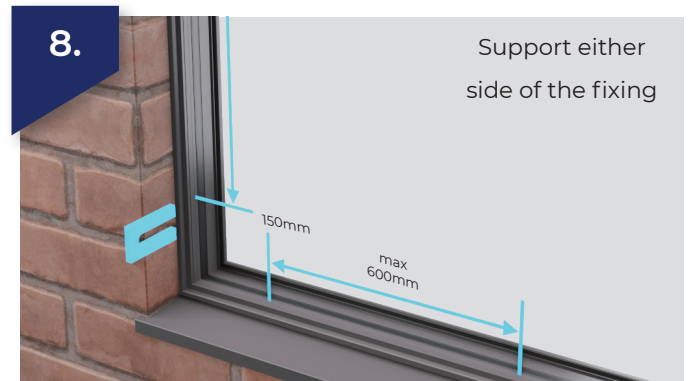

Support either side of the fixing. Pack around the frame using full-width packers ensuring that it's square and level and ensuring a 5mm gap is maintained. Drill pilot holes around the frame at min 150mm from corners and min 600mm centres in between, ensuring at least 2 fixings per side.

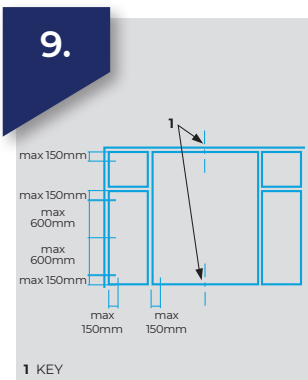

Additional fixings required for frames over 1.8m top and bottom as shown, in line with industry codes of practice.



Prior to fixing the frame, silicone the holes in the bottom of the frame to prevent water ingress.



Fix the frame into the aperture using suitable 100mm frame fixings to suit construction material.



OPTIONAL: If fitting using fixing cleats, make sure they are securely fastened to the window and through the appropriate fixing holes internally.



whiteline

# Glazing Openers and Dummy Sashes

Remove handles and beads from the window and place them to one side. Beads must be returned to original position once glazed so make a note of where they come from. Ensure all gaskets are inserted into the respective rebates and beads before the glazed unit is fitted.



13.

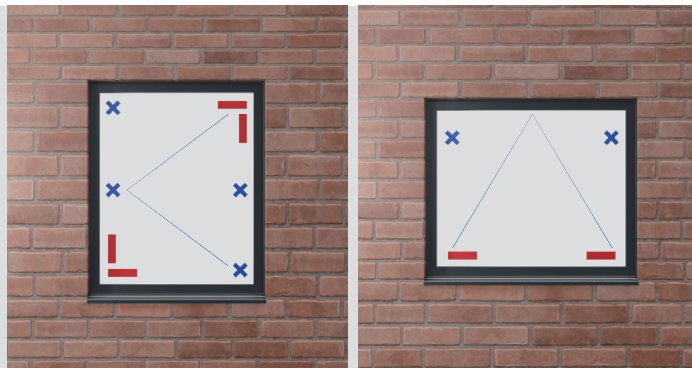

Fit the glazed unit into the sash and pack / toe & heel in the appropriate places using glazing packers as shown. Toe & heeling should distribute the weight of the glass correctly to ensure the window is square and aligned. Using glass packers at the opposite corners of the sash as shown, creates diagonal support across the glass unit, ensuring the window operates correctly.

\*Position packers in line with locking points to meet PAS 24 requirements

14.



Spray the glass unit with a mild soap/water mix or glass cleaner to prevent the gasket sticking while the bead is being fitted.

15.



Start by locating the front leg of the bead into the receiving channel and rotate the bead until it 'clips' into place. Fit the top bead first to secure the unit. Continue to fit the bottom bead and then the sides being careful not to scratch the powder coated finish.

If the gasket is not seated correctly, use a glazing shovel to gently press the gasket into the bead to give a nice smooth finish.

# Glazing Fixed Panes

Remove beads from the window and place them to one side. Beads must be returned to original position once glazed so make a note of where they come from. Ensure all gaskets are inserted into the respective rebates and beads before the glazed unit is fitted.



16.



Toe & Heel

Pack square\*

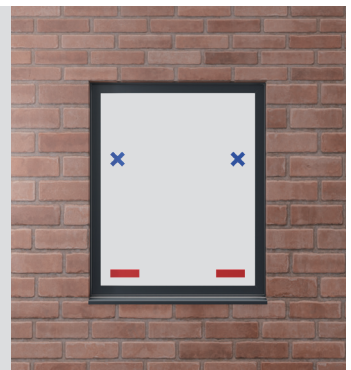

The SH128 external/internal Glazing clip base should already be fitted as shown above.

Add the foam strips to the L shaped bracket for the SH128 and clip into place ensuring a positive clip has taken place before securing the glass in the frame.

\*Position packers in line with locking points to meet PAS 24 requirements

- <600mm 1 clip per side
- 600mm – 1200mm 2 clips per side
- >1200mm 3 clips per side

*Note: SH918 Glazing Clip Deglazing Tool required when removing glass.*

17.



Spray the glass unit with a mild soap/water mix or glass cleaner to prevent the gasket sticking while the bead is being fitted.

18.



Fit the top bead first to prevent the glazed unit from falling out of the window, continue to fit the bottom bead and then the sides being careful not to scratch the powder coated finish.

If the gasket is not seated correctly, use a glazing shovel to gently press the gasket into the bead to give a nice smooth finish.



whiteline

# External Finishing & Final Checks

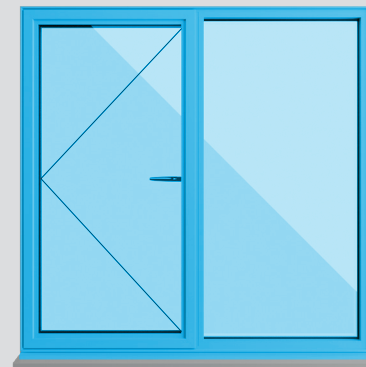

19.

Break off any protruding packers where necessary.

20.

Remove protective tape from all profiles. Clean down aluminium and glass with warm, soapy water.

21.

Expanding foam can be used to fill any large apertures around the frame. Be careful not to overfill. Now trim or silicone around outer frame and seal below external cill if applicable.

22.

Check the window for correct function.

23.



If you need to adjust the compression on window sashes, to ensure they open with minimal effort but maintain a tight seal when closed. Adjust the locking pins on the espag lock using a 4mm allen key. Turning clockwise or counter-clockwise, to decrease or increase the contact pressure between the sash and frame as required.





# Operational Sash Removal

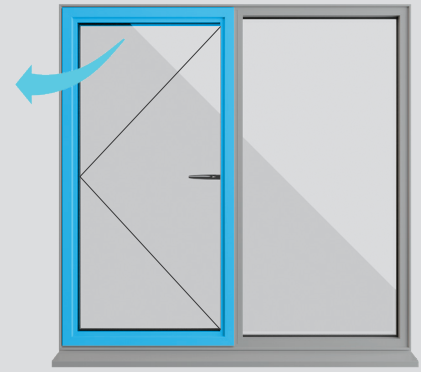

**IMPORTANT:** If large windows have arrived to site with the sashes installed you may want to remove them before installation to stay within safe manual handling limits.

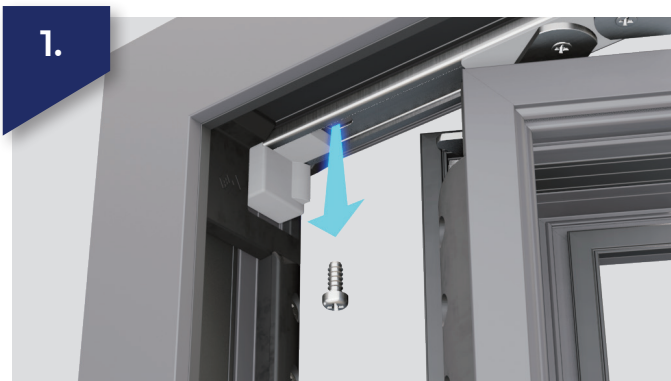

1. Remove the screws holding the hinge to the frame while holding the sash securely.



2. Holding the sash securely, tilt the hinges away from the corner hinge locators and lift out.



3. Lift carefully away as shown.

# Dummy Sash Removal

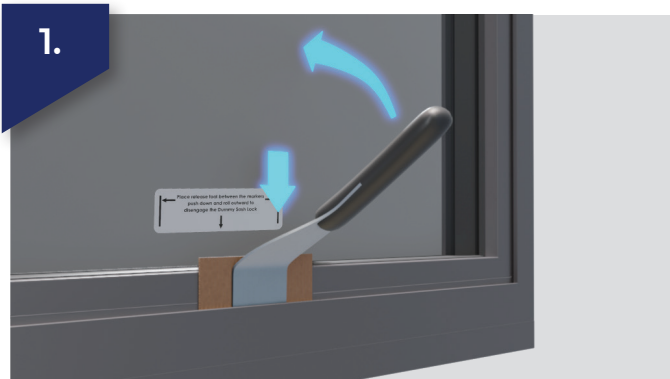
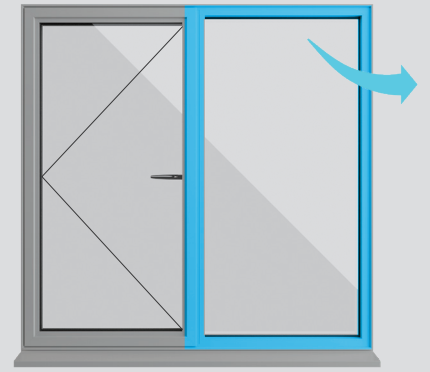

1. If already fitted, release the sash by locating the dummy sash packer using the release tool. Press down firmly onto the paddle plate before rolling forward onto the sash to disengage the lock, ensuring you have put protective padding in place to protect the sash.

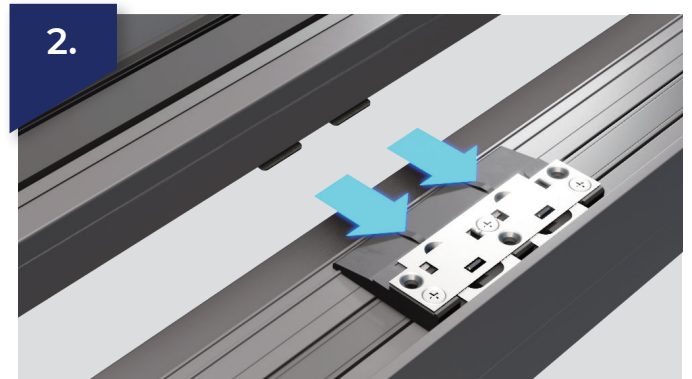

2. Please Note: the lock can be reengaged at any time to resecure the dummy sash in position.

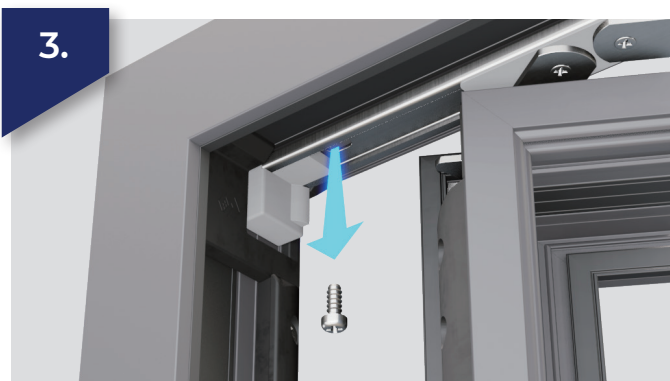

3. Make sure you have a safe and protected surface to lay the dummy sash once you've removed it. Start by unscrewing the sash.



4. Holding the sash securely, tilt the hinges away from the corner hinge locators and lift out.



# Fixed Pane Removal

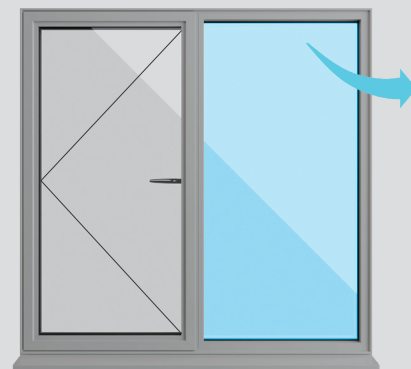

1. Place the de-glazing tool under the sealed unit to the back of the window section as shown. Then slide the de-glazing tool to the left / right until it meets the Securi-clip and pull towards you.

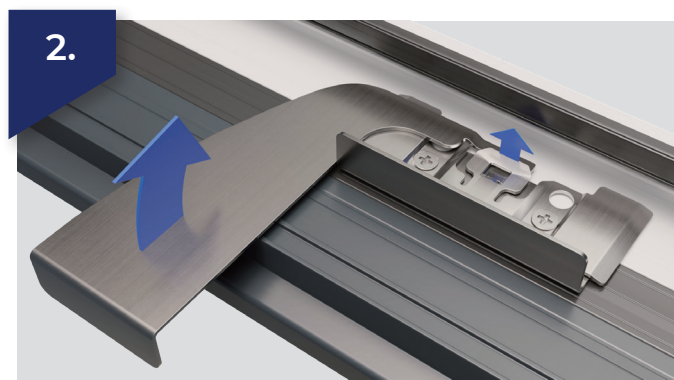

2. Lift the de-glazing tool to engage between the base unit and securi-clip.

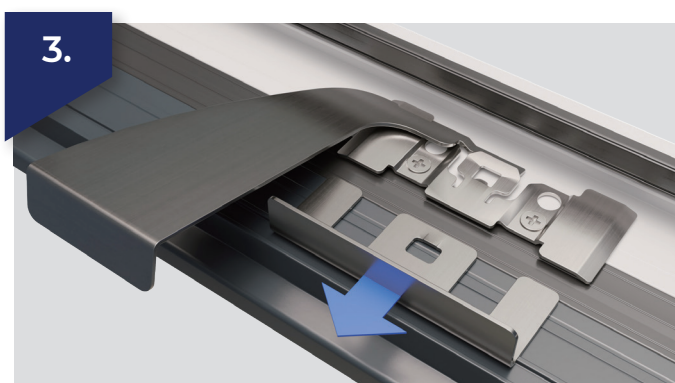

3. Place the handle part of a second de-glazing tool between the clip and the glass and pull the clip out as shown.

# Operational Sash Fitting

Clear the frame of any debris before fitting the sashes.

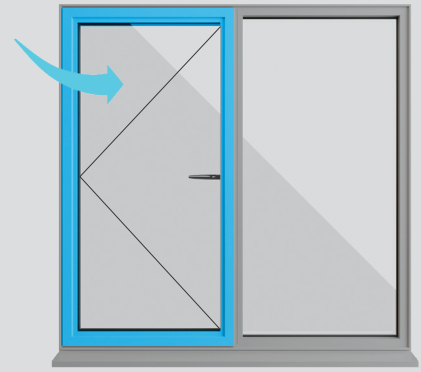

1.



Place the back edge of the hinges in the corner hinge locators, and then rotate the sash forward locating the front edge of the hinge into the run up ramps.

2.

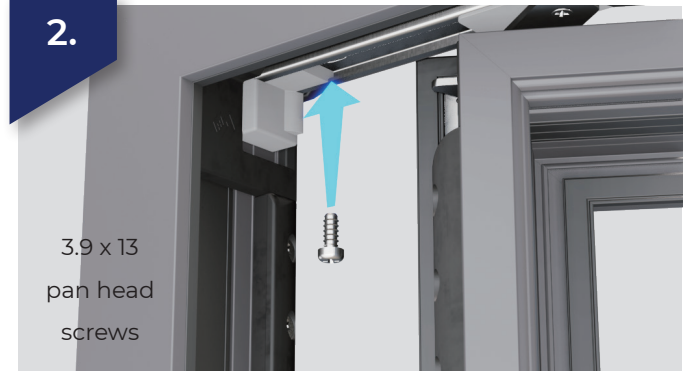

3.9 x 13  
pan head  
screws

Once the sash is firmly located it will be held firmly in place allowing you to fix the hinge using 3.9 x 13 pan head screws. Once complete test for correct operation and repeat as required.

3.

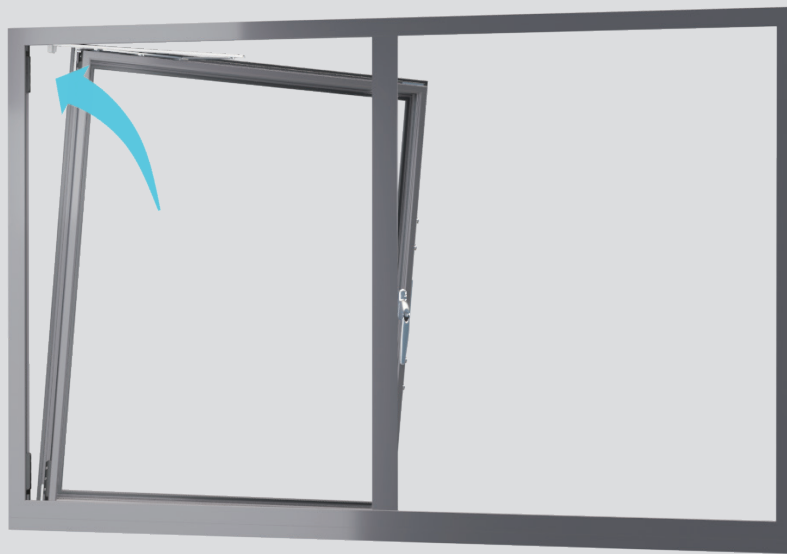

Locate carefully as shown.



# Dummy Sash Fitting Instructions

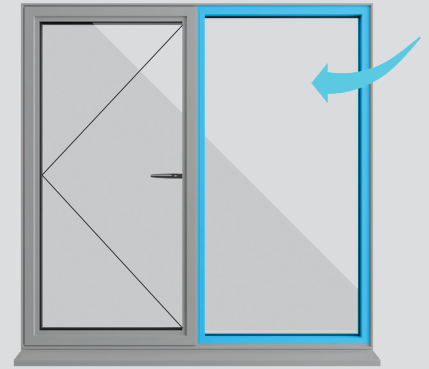

Clear the frame of any debris before fitting the sashes.

Note: the procedure for removing the dummy sash is detailed on p4.

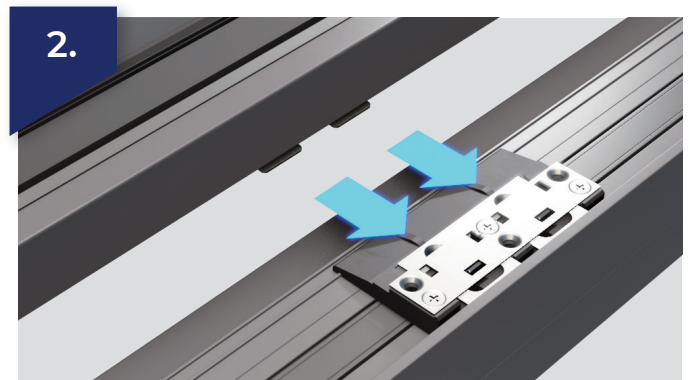

If not already fitted: The dummy sashes should be supplied with a two-pronged device. This is usually taped to the window, along with packing pieces and fixing screws. These are installed underneath the odd leg of the sash and the holes should have been predrilled. When you are satisfied with the alignment ease the dummy sash into position.

Once located give a firm push on the sash to engage the teeth and lock the sash into the frame. Make sure to push firmly on both devices to ensure good gasket compression. Check that the gap between the sash and the outer frame is consistent from left to right and that everything is parallel.

**IMPORTANT NOTE:** ensure the packer is used (highlighted above), so that the sash can be removed later if necessary.

## Bead Removal

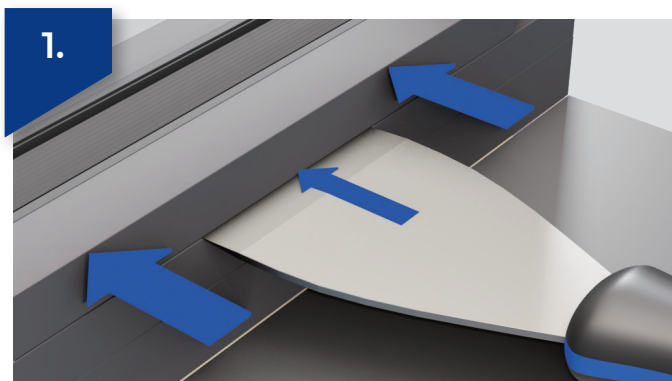

Press the top edge of the bead toward the glass, creating a gap between the bead and the frame/ sash.

Using a thin pallet knife or appropriate tool, insert the tool in the gap created and lever away from the bead to disengage from the fixed profile.

## Video Links

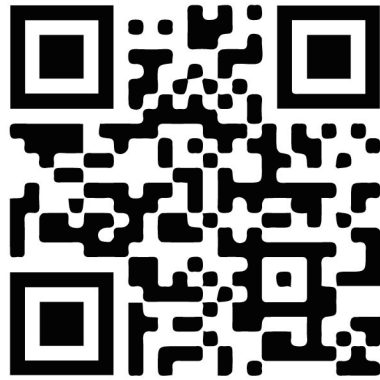

Dummy Sash Lock  
Fabrication & Operation

Please send any photos of your installation to  
**[marketing@whiteline.co.uk](mailto:marketing@whiteline.co.uk)** so we can share your work.



whiteline











MADE IN  
BRITAIN

